

Una Poulsen

Mandy on holiday

Avritssiður

Innihaldsyvirlit

Logbook

- Perma og frágreiðing
- My logbook 1 2

English words that I know

Island Travelling

- Spæl
- Frágreiðing um spælið
- Svarlisti
- Spurningar 1 2 3 4

Family cards

- Family cards 1 2 3 4

Travelling

- Do you know the countries?

Colours

- What is your favourite colour?
- Flags

Clothes

- Orðakort 1 2 3 4 5 6
- Myndir til spøl o.a.

Find the opposite word

- Opposite pairs 1 2 3 4 5 6
- Orð og týdningur

Animals and their young ones

- Memory 1 2

Zoo animals

- Memory 1 2 3 4
- Myndir til spøl o.a.

Numbers

- Telephone numbers

The weather

- Veðurkort /Ítriv 1 2 3

The clock

- Klokka við pinnum

Peter and Mandy go fishing

- Domino 1 2 3

Helping on the farm

- Domino 1 2 3

Rammur til spøl

- 9 rammur
- 8 rammur
- 12 rammur
- Picture lottery
- Domino

Bingoplátur

- 4 puntar
- 9 puntar

Dømi um loggbók í byrjanarundirvísingini.
Næmingar læra at orða seg á enskum.

Avritssíða 1: Kopiera eitt eintak til permu.

Avritssíður 2 og 3: Kopiera tað tal av avritssíðum, sum tú ynskir.
Minst til at printa á báðum síðum.
Klipp eftir stiplaðu linjuni, falda og heft.

What I did at home:

Næmingarnir skriva stutt, hvat ið teir gjørdu heima.
Teir kunnu t.d. hava sæð ein enskan film
ella spælt eitt telduspæl við enskum teksti.

What I did at school:

Næmingarnir skriva stutt, hvat ið teir gjørdu í skúlanum.
Teir seta merki við eitt av SMILEY-andlitunum fyri at siga,
hvussu teimum dámdi.

Homework:



Næmingarnir skriva, hvat ið teir *fara at gera / skulu gera* heima.

My logbook

Name:

Date: _____

What I did at home:

What I did at school:   

Homework: 

Date: _____

What I did at home:

What I did at school:   

Homework: 

Date: _____

What I did at home:

What I did at school:   

Homework: 

Date: _____

What I did at home:

What I did at school:   

Homework: 

Date: _____

What I did at home:

What I did at school:   

Homework: 

Date: _____

What I did at home:

What I did at school:   

Homework: 

Date: _____

What I did at home:

What I did at school:   

Homework: 

Date: _____

What I did at home:

What I did at school:   

Homework: 

English words that I know

✓ Tick the words that you know (Set merki við tey orð, sum tú kennir)

Sports

badminton
bowling
basketball
crawl
hockey
jockey
knock-out
old boys
skateboard
surfing
rugby

Spare time & hobbies

babysitter
breakdance
bingo
camera
camping
jogging
party
quiz
swimming pool
weekend
western

Music & technology

cassette
computer
disc jockey
ghetto blaster
rock
TV
video
walkman

Food and drink

bacon
burger
cornflakes
hot dog
juice
milkshake
popcorn
sandwich
soft ice
toast

Clothes

boxer shorts
jeans
overalls
pyjamas
shorts
T-shirt

Other words

baby
carport
container
cowboy
gangster
handicap
interview
punk
shampoo
tape

Island Travelling



Island Travelling • Frágreiðing um spælið

Island Travelling kann takast av netinum í passandi stødd og laminerast.
Spælið er ætlað at læra næmingarnar oyggjarnar, samstundis sum teir læra nýggj ensk orð. (www.fsg.fo – Mandy on holiday)

Tal av spælarum: tveir ella fleiri

Tú skalt nýta:

- ein terning
- brikkar í ymsum litum, ein brikk til hvønn spælara
- myndakort

48 myndakort við svarlista eru til spælið. Tey kunnu takast av netinum og laminerast.

Næmingarnir kunnu móguliga lita kortini.

Nýggj kort kunnu gerast til spælið, tá ið ein tíð er fráliðin.

Spælararnir skiftast at ringla og flyta sínar brikkar eftir tølunum.

Tað ræður um at verða fyrstur aftur á START.

Kemur ein spælari á reyðan ring, skal hann fyrri at kunna flyta siga, hvat stað á kortinum talið sipar til.

Hann skal síðani taka eitt myndakort og á enskum siga,

hvat myndin á kortinum vísir. Dugir hann tað, kann hann flyta brikkin eitt fram.

Gev gætur!

Í fyrstani kann næmingurin móguliga sleppa at flyta á reyðan ring, sjálvst um hann ikki veit navnið á staðnum.

Spælararnir kunnu so í felag finna út av navninum.

-
- brikkur: *counter / piece / man*
 - terningur: *dice*
 - terningabikar: *dicebox / dice cup / shaker*
 - at ringla: *to throw the dice / to rattle (the dice)*
 - at fáa ein seksara: *to throw a six (on the dice)*

Island Travelling • Svarlisti til kort

- | | |
|-----------------------------------------|-----------------------------------------|
| 1. school bag (<i>skúlataska</i>) | 25. cat (<i>ketta</i>) |
| 2. pencil case (<i>penalarhús</i>) | 26. goose (<i>gás</i>) |
| 3. books (<i>bøkur</i>) | 27. duck (<i>dunna</i>) |
| 4. pencil (<i>blyántur</i>) | 28. dog (<i>hundur</i>) |
| 5. pen (<i>pennur</i>) | 29. pilot whale (<i>grindahvalur</i>) |
| 6. eraser (<i>viskileður</i>) | 30. shark (<i>hávvur</i>) |
| 7. crayon (<i>litblyántur</i>) | 31. monkey (<i>apa</i>) |
| 8. ruler (<i>lineal</i>) | 32. kangaroo (<i>kenguru</i>) |
| 9. car (<i>bilur</i>) | 33. giraffe (<i>giraffur</i>) |
| 10. bus (<i>bussur</i>) | 34. horse (<i>ross</i>) |
| 11. aeroplane (<i>flogfar</i>) | 35. crocodile (<i>krokodilla</i>) |
| 12. helicopter (<i>tyrla</i>) | 36. elephant (<i>filur</i>) |
| 13. train (<i>tok</i>) | 37. bear (<i>bjørn</i>) |
| 14. sheep (<i>seyður</i>) | 38. lion (<i>leyva</i>) |
| 15. rat (<i>rotta</i>) | 39. tiger (<i>tikari</i>) |
| 16. pig (<i>grísur</i>) | 40. panda (<i>panda</i>) |
| 17. starling (<i>stari</i>) | 41. camel (<i>kamelur</i>) |
| 18. sparrow (<i>spurvur</i>) | 42. seal (<i>kópur</i>) |
| 19. crow (<i>kráka</i>) | 43. snake (<i>slanga</i>) |
| 20. pigeon (<i>dúgva</i>) | 44. zebra (<i>sebra</i>) |
| 21. hare (<i>hara</i>) | 45. rhino (<i>nashyrningur</i>) |
| 22. marsh marigold (<i>mýrisólja</i>) | 46. polar bear (<i>hvítabjørn</i>) |
| 23. daisy (<i>summardái</i>) | 47. hippo (<i>áarross</i>) |
| 24. daffodil (<i>páskalilja</i>) | 48. penguin (<i>pingvin</i>) |

Nøvn á kortinum

- | | |
|-------------------------|-------------------------|
| 3. the Faroe Islands | 25. the Isles of Scilly |
| 7. the Shetland Islands | 28. Wales |
| 10. the Orkney Islands | 31. the Isle of Man |
| 12. Scotland | 34. Ireland |
| 15. England | 37. Northern Ireland |
| 18. the Isle of Wight | 40. the Hebrides |
| 21. the Channel Islands | [ˈhebridiːz] |

Island Travelling • Spurningar (1) 2 3 4

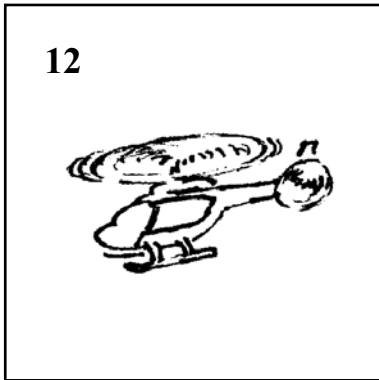
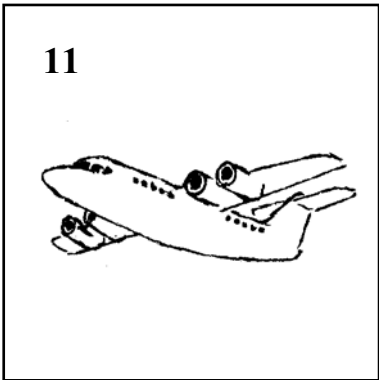
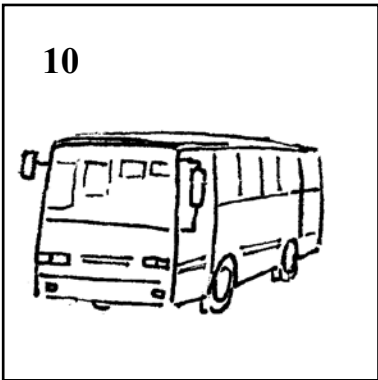
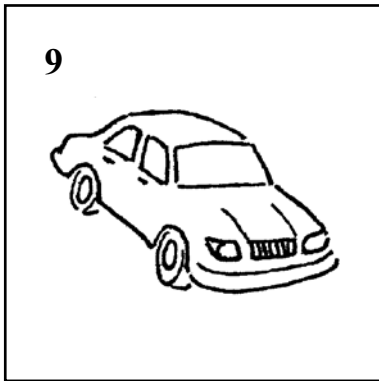
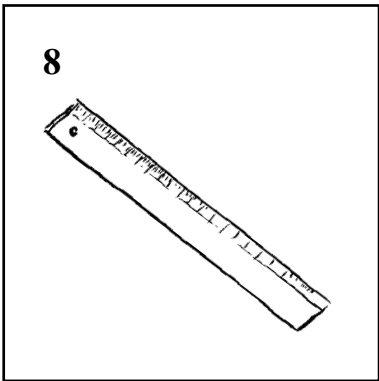
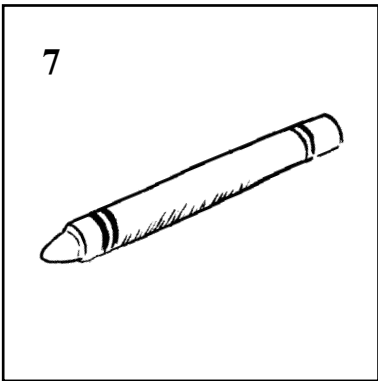
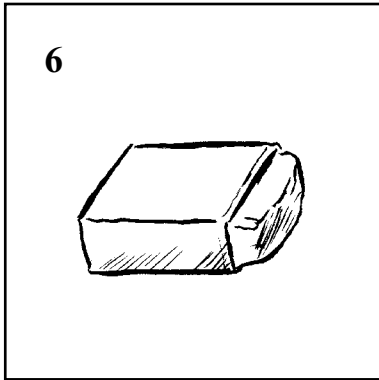
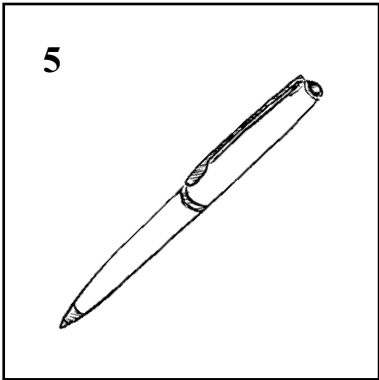
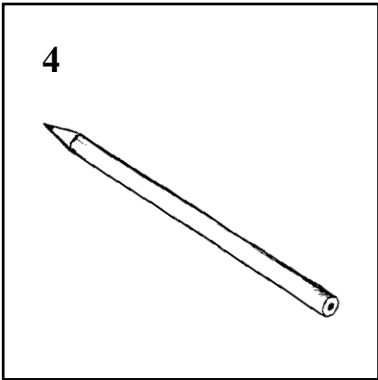
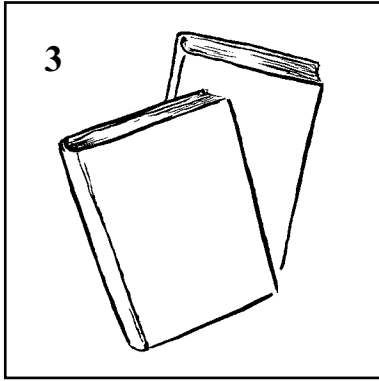
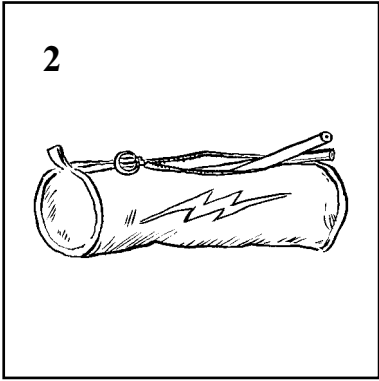

Island Travelling • Spurningar 1 (2) 3 4

13

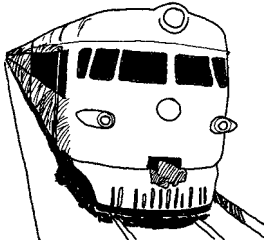

14

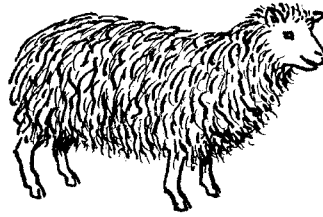

15



16

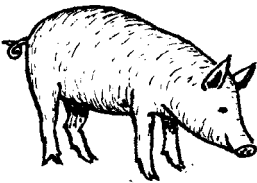

17



18

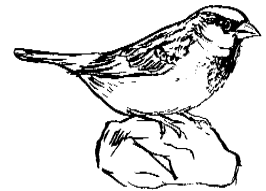

19



20

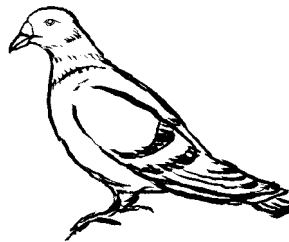

21

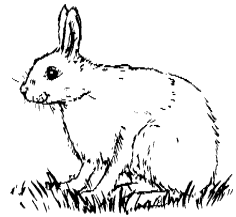

22



23



24



Island Travelling • Spurningar 1 2 (3) 4

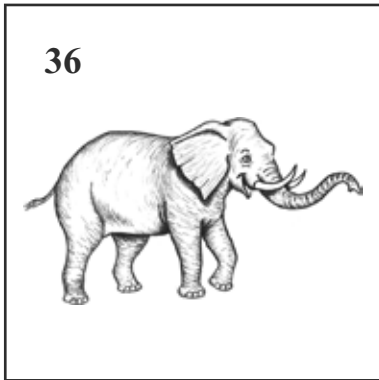
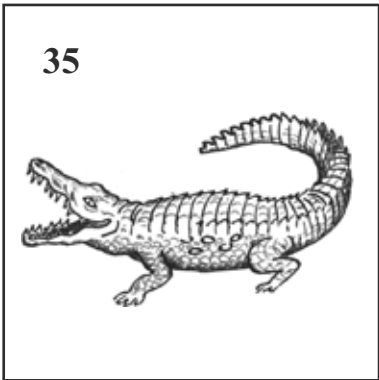
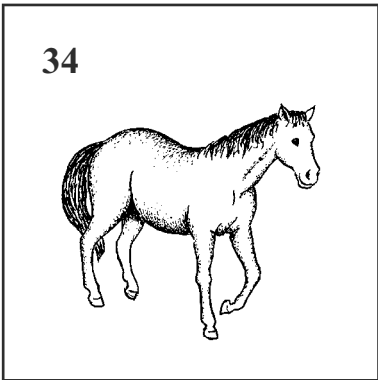
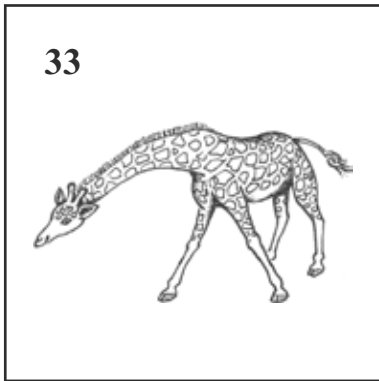
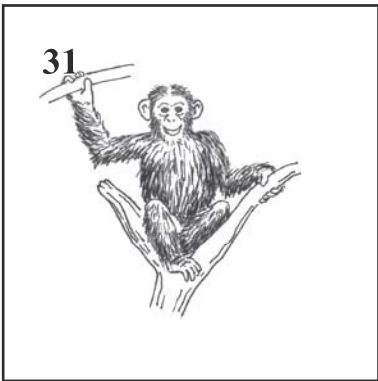
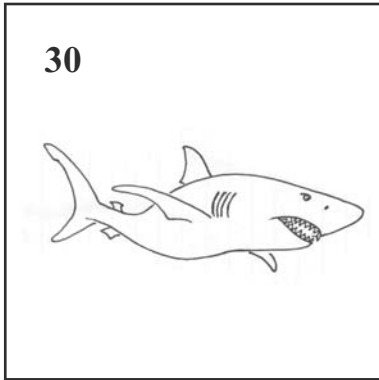
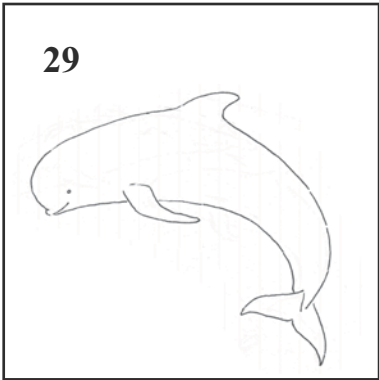
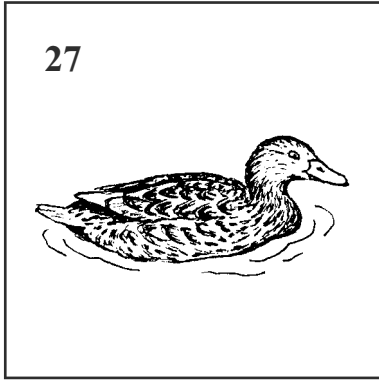
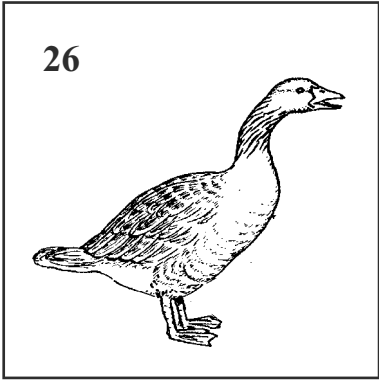
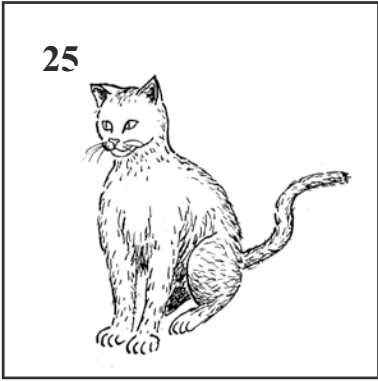

37



38



39



40



41



42



43



44



45

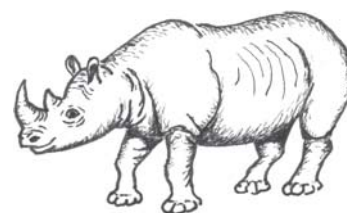

46

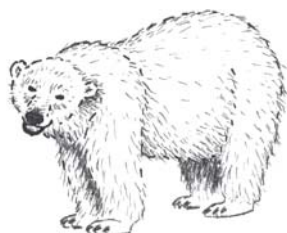

47

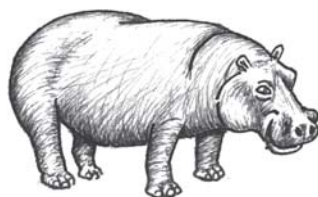

48

